

SUBWAY CAR - COM#2405

ASSEMBLY INSTRUCTIONS

Before starting this kit, make sure you read through all the instructions carefully. Always remember to dry fit parts and sand as needed.

We use two kinds of glue when assembling our kits. Super glue (cyanoacrylate) or PVA glue.

You can repaint or weather our kits easily! The paint we use is a great base primer and will take paint nicely.

If you have any issues during assembly, please contact us and we'll always help!

We would like to take the time to thank you for purchasing a Black Site Studios product!

www.blacksitestudio.com

WE SUGGEST HAVING THESE TOOLS ON HAND



IMPORTANT SYMBOLS YOU'LL FIND ON YOUR JOURNEY



ATTENTION



DRY FIT



NO GLUE



GLUE



TRIM/SAND

SUBWAY CAR - COM#2405

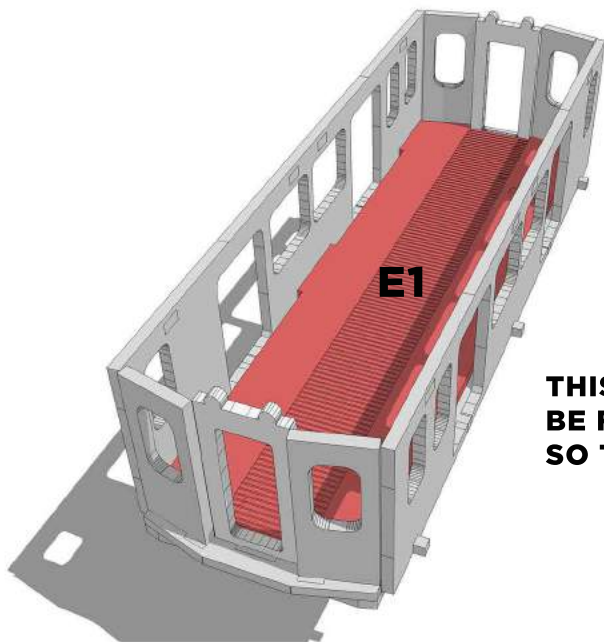
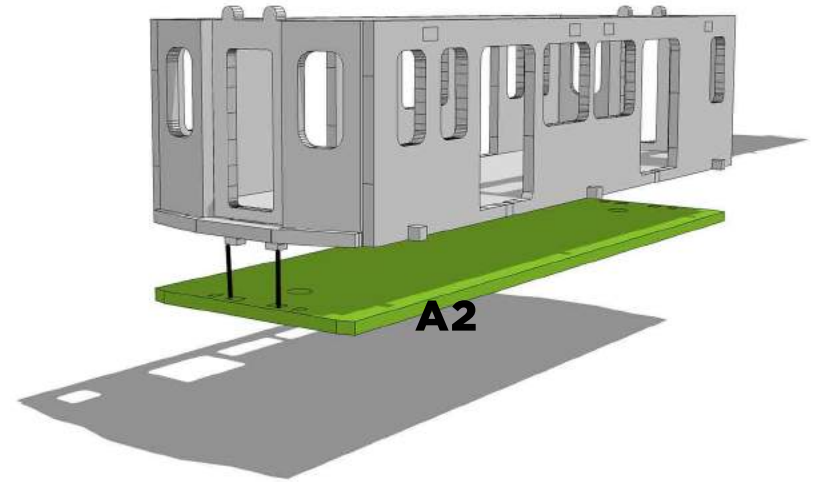
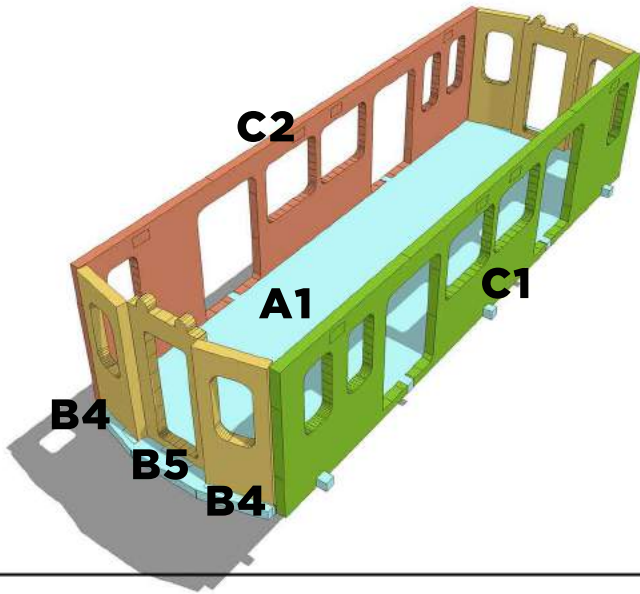

**THIS PART CAN
BE FAIRLY TIGHT
SO TRIM IF NEEDED**

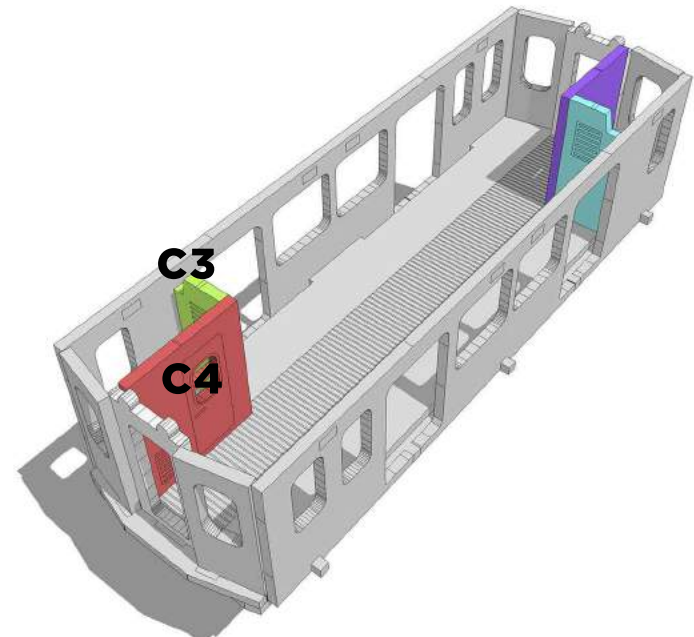

SUBWAY CAR - COM#2405

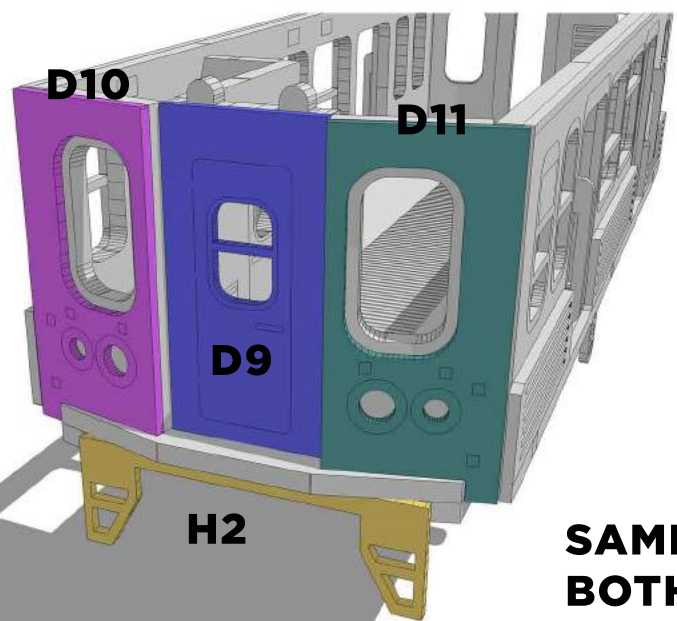
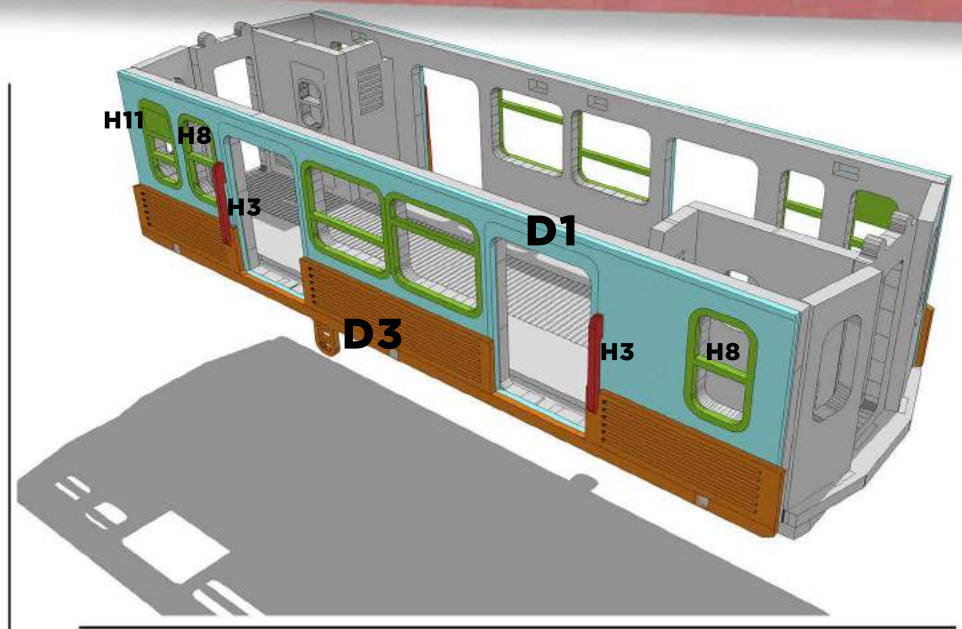
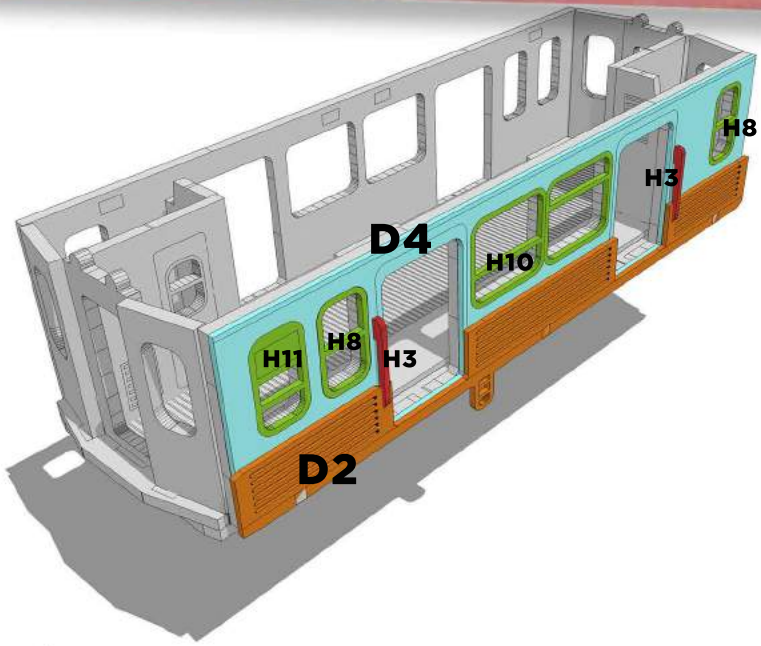

SAME ON BOTH SIDES

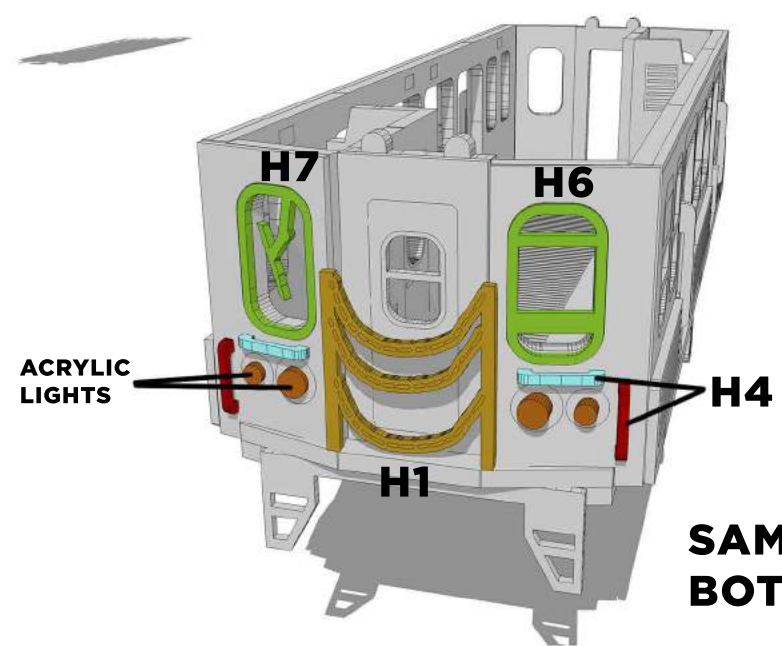

SAME ON BOTH SIDES

SUBWAY CAR - COM#2405

MAGNET

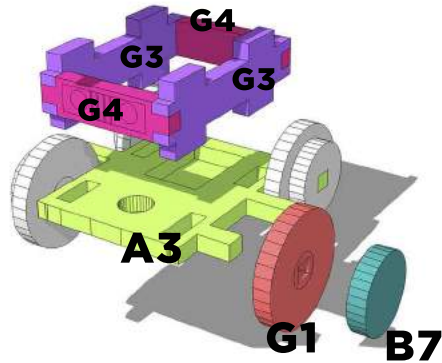
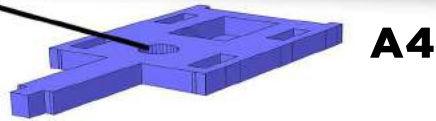

NOW ITS TIME TO ASSEMBLE THE WHEEL BASES.

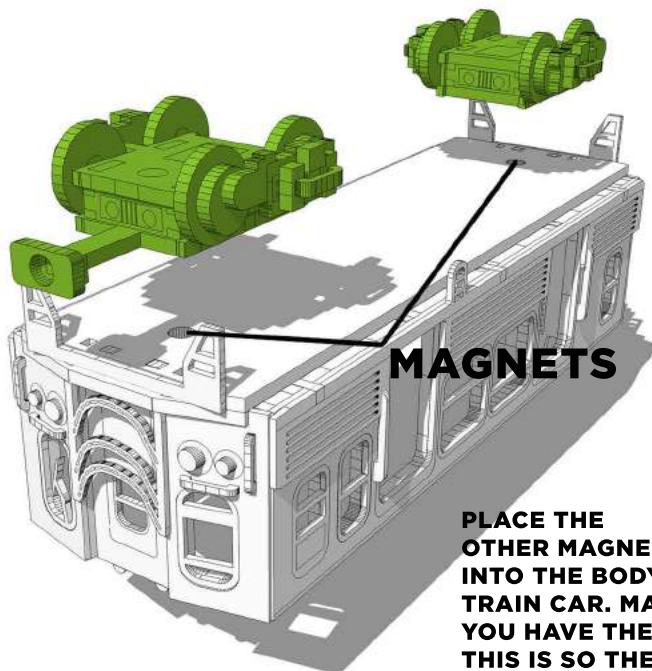
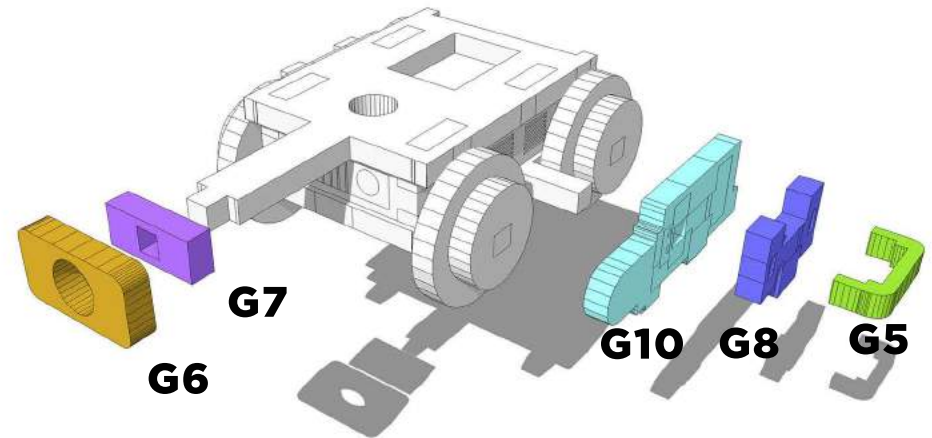

MAGNETS

PLACE THE OTHER MAGNETS INTO THE BODY OF THE TRAIN CAR. MAKE SURE YOU HAVE THE POLARITY RIGHT. THIS IS SO THE WHEELS CAN SWIVEL

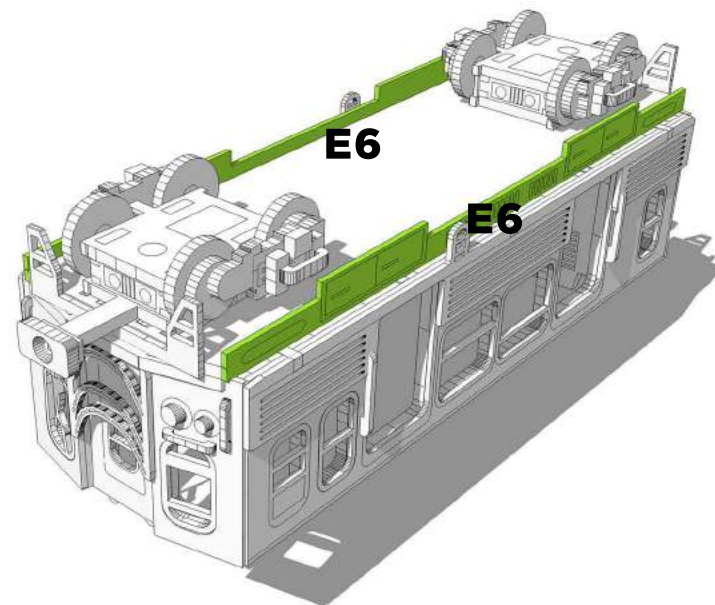

SUBWAY CAR - COM#2405

**THESE DOORS
ARE DESIGNED
TO SLIDE OPEN.**

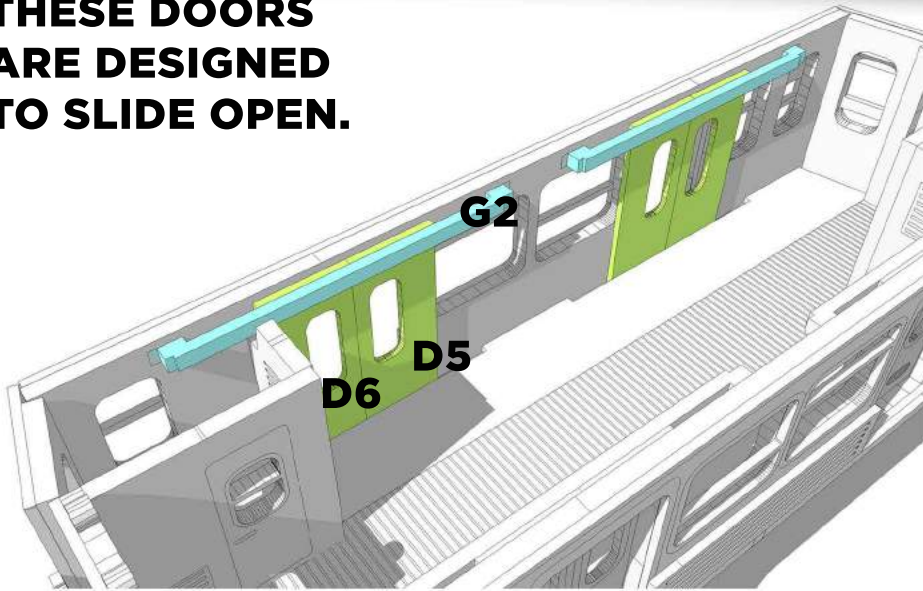

**THIS PART IS DESIGNED
TO STOP THE DOORS FROM
POPPING OUT. TAKE CARE
WHEN GLUING IT IN THAT
YOU DONT GET GLUE ON
THE DOORS.**

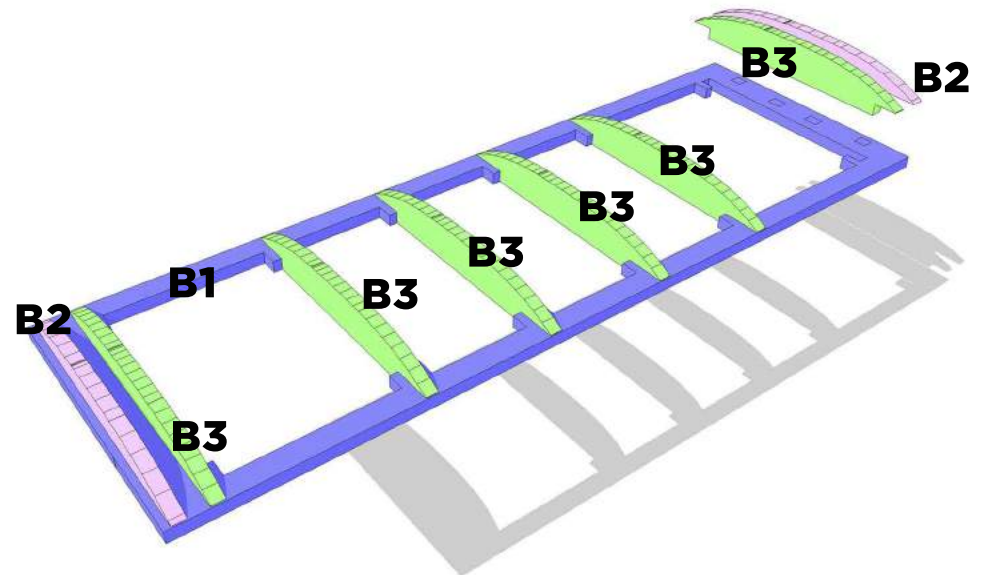
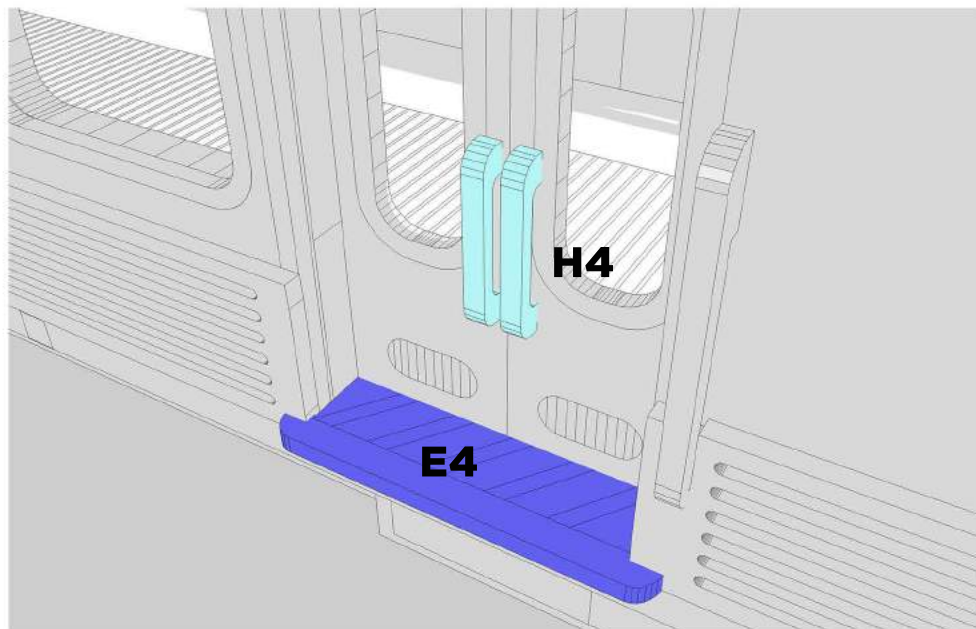
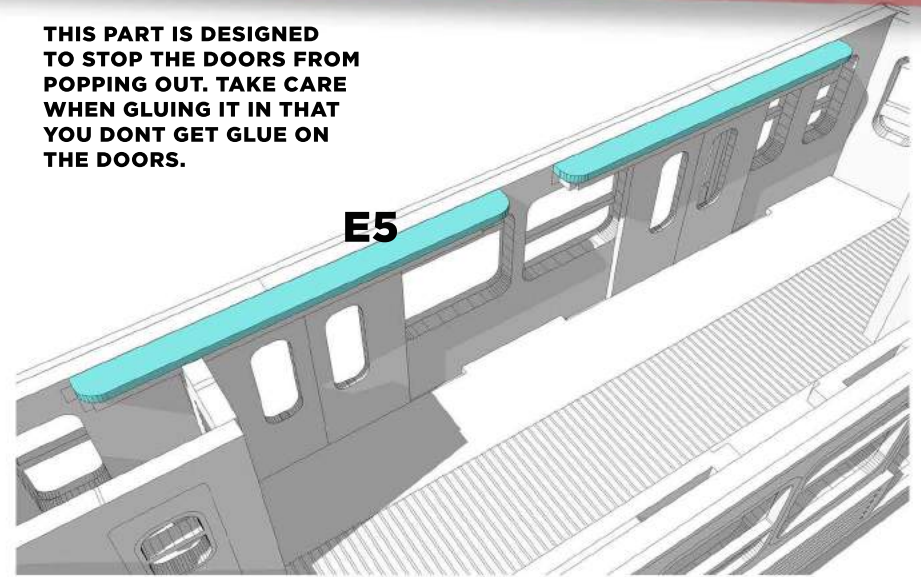

SUBWAY CAR - COM#2405

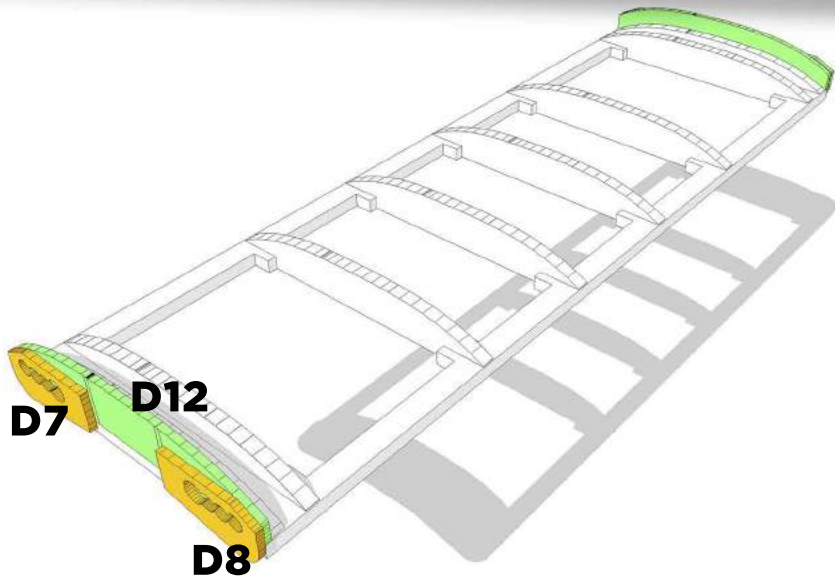

PLACE CORRUGATED
CARD LAYER OVER ROOF.
YOU MAY NEED TO TRIM
THIS TO FIT.

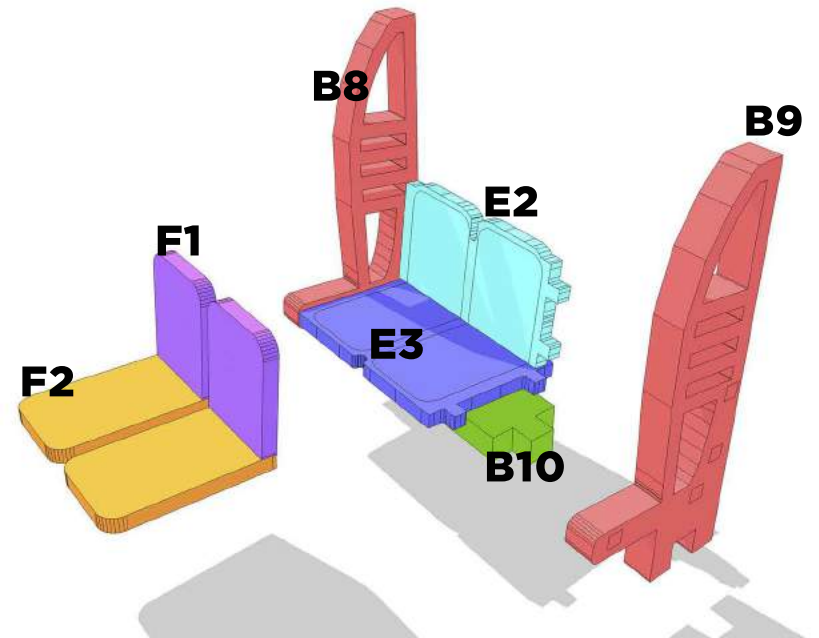
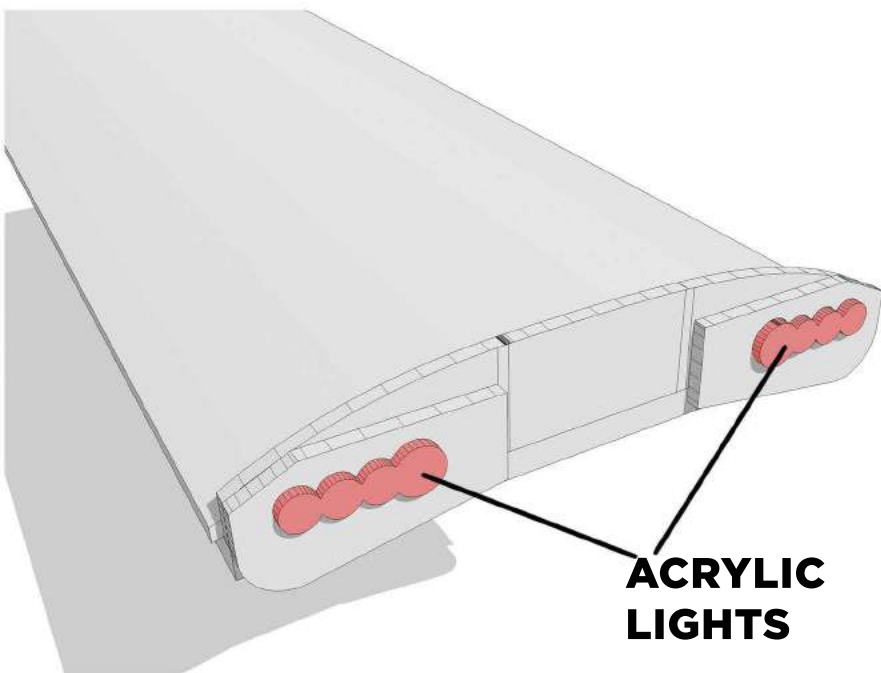
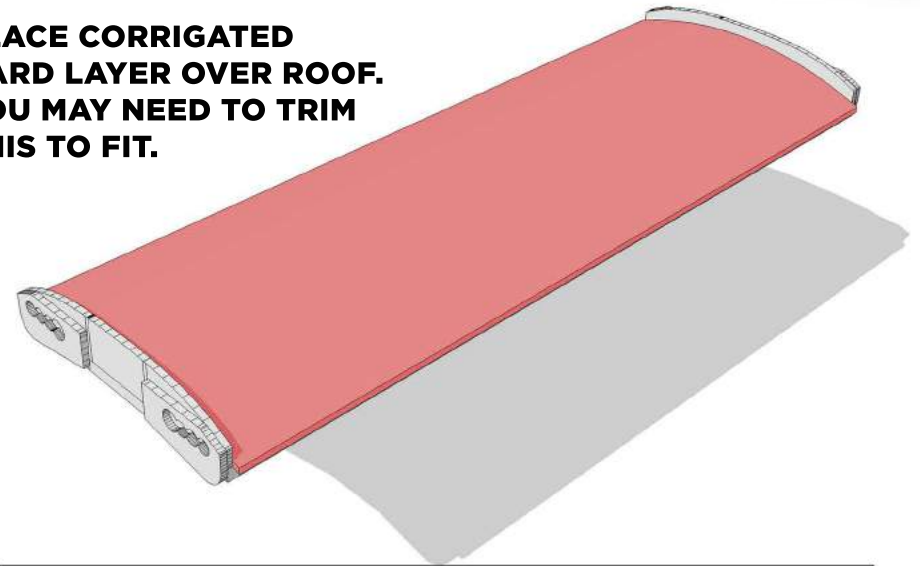

LEAVE ASSEMBLED SEATS UNGLUED FROM TRAIN
FOR EASIER GAMING