

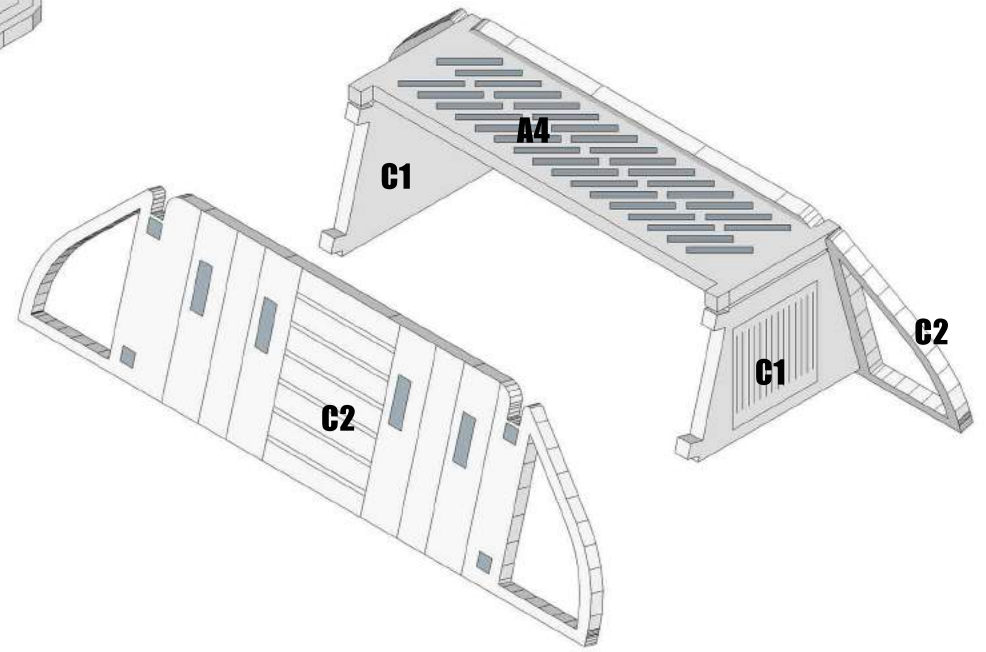

PSB DISTRIBUTION DISH

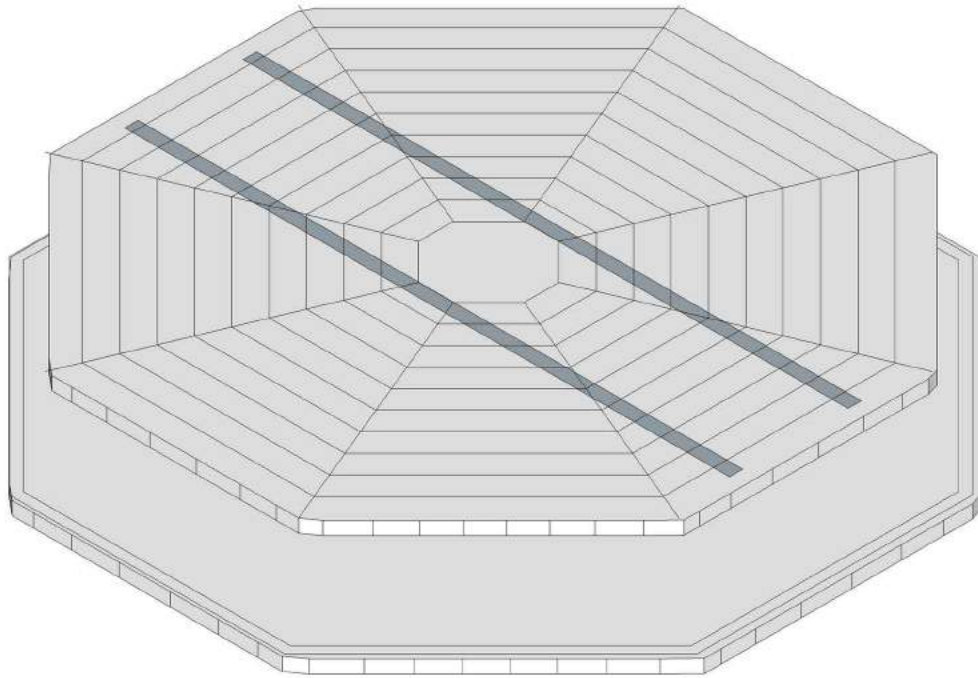



PSB DISTRIBUTION DISH

**YOU CAN CHOOSE TO GLUE
THESE PARTS TOGETHER, OR
LEAVE THEM UNGLUED.**

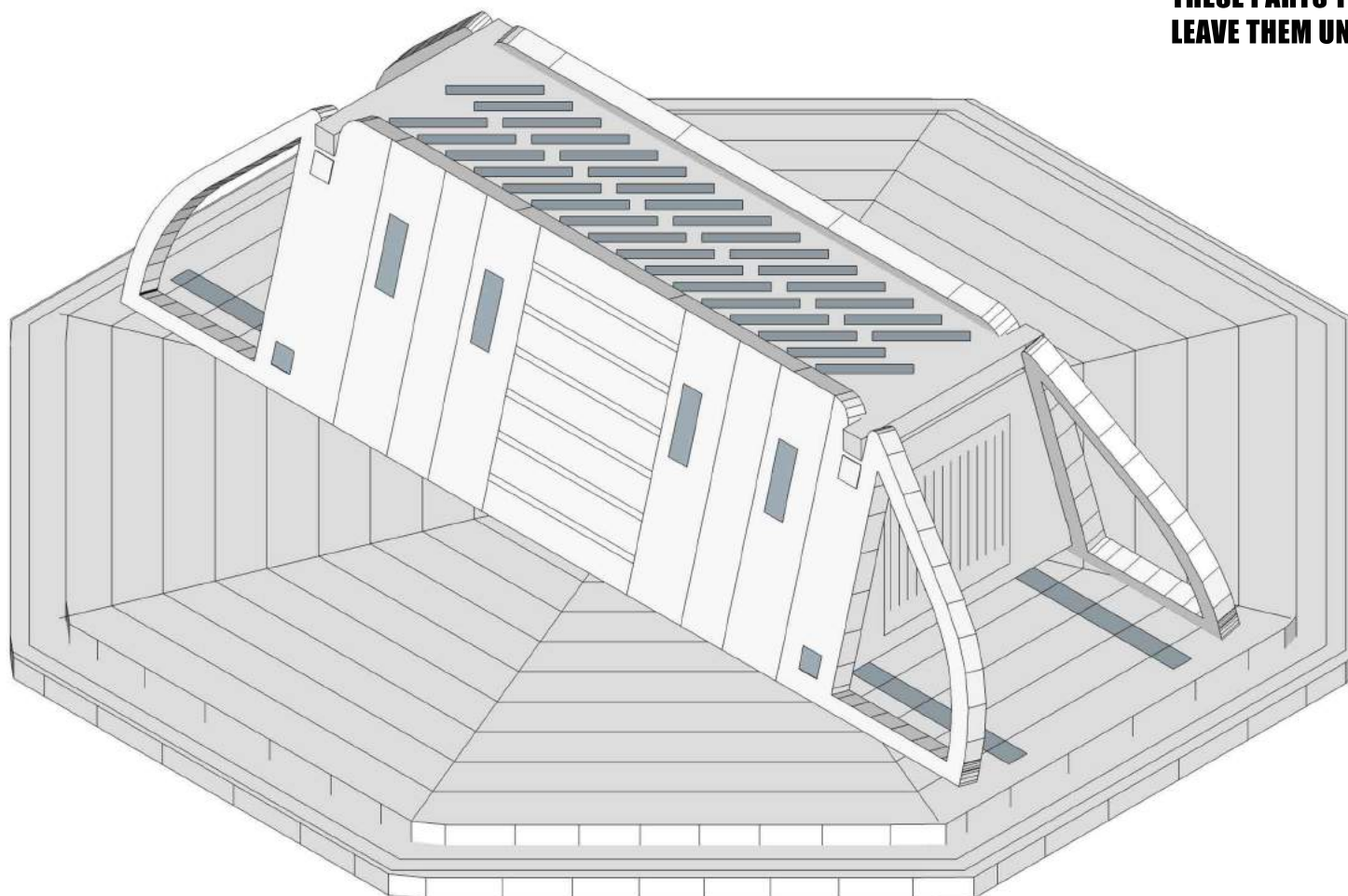



PSB DISTRIBUTION DISH

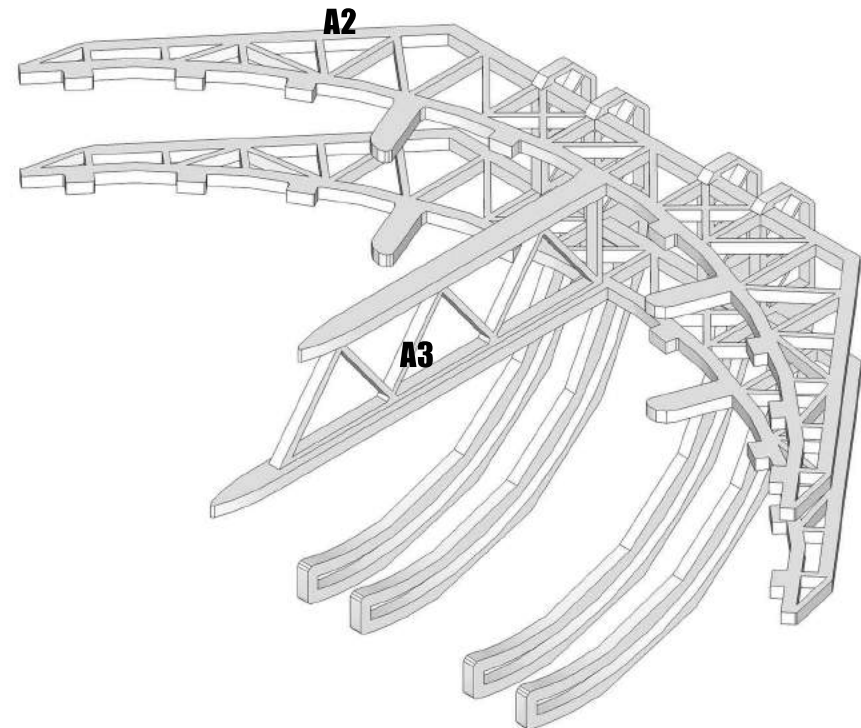
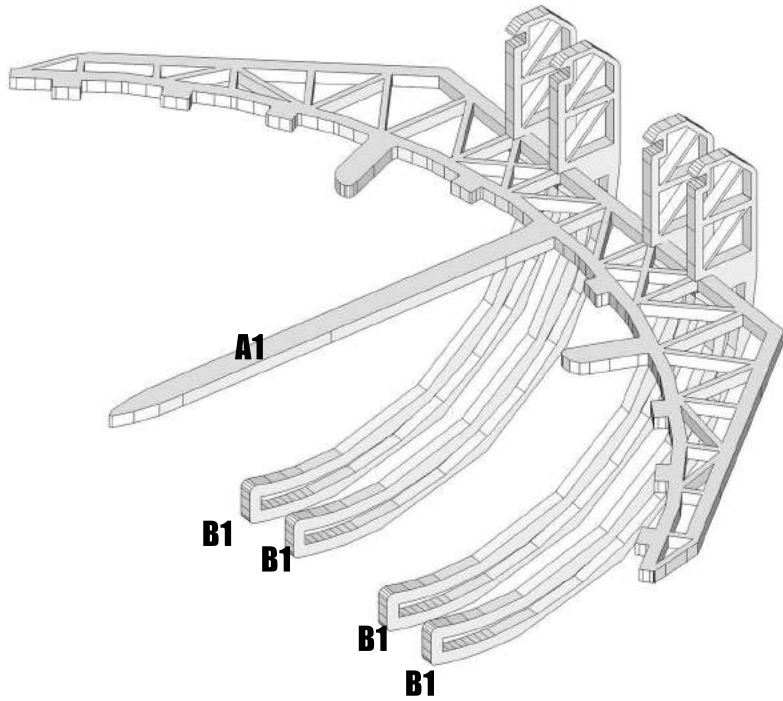



PSB DISTRIBUTION DISH

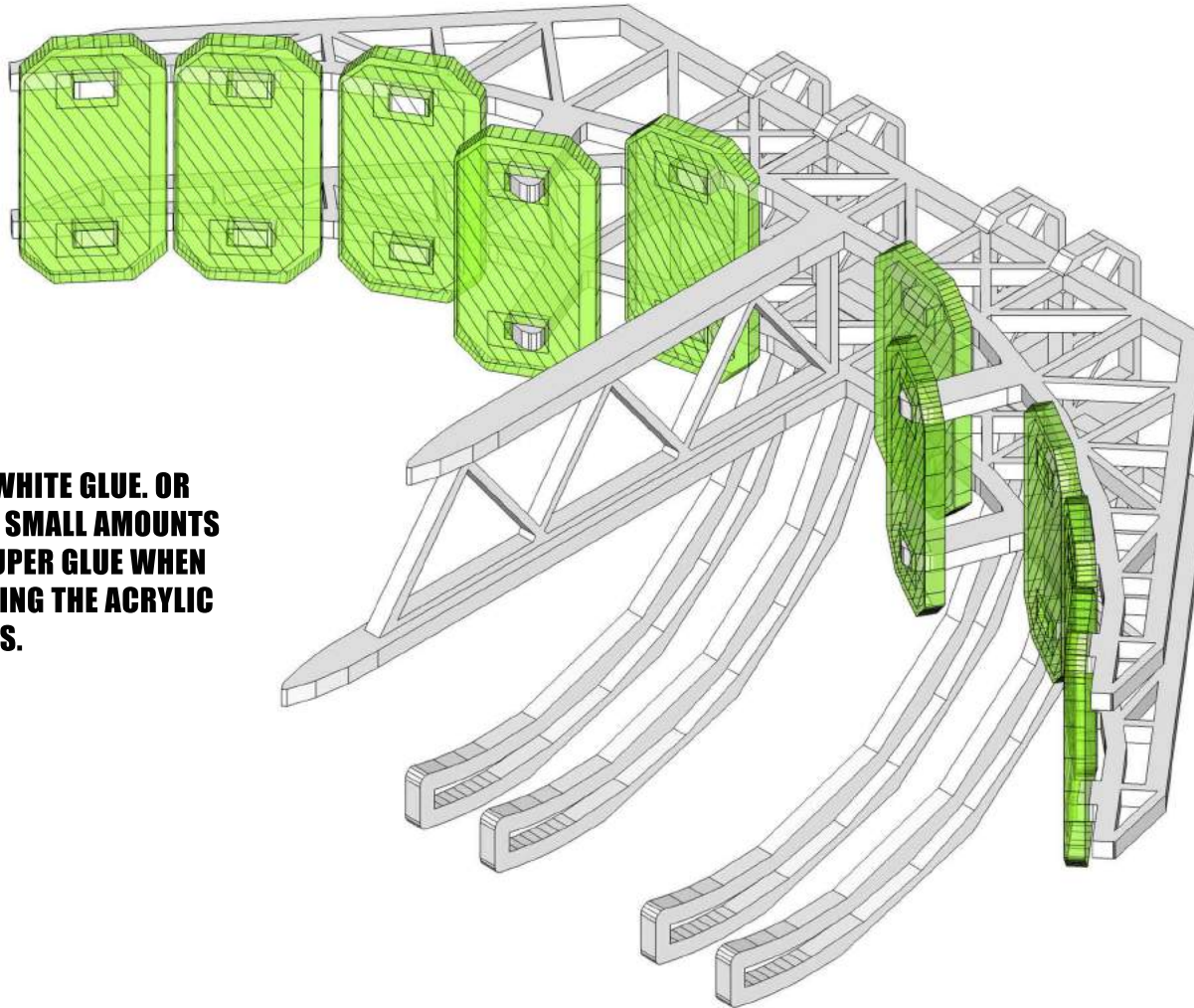

**USE WHITE GLUE. OR
VERY SMALL AMOUNTS
OF SUPER GLUE WHEN
PLACING THE ACRYLIC
PARTS.**



PSB DISTRIBUTION DISH

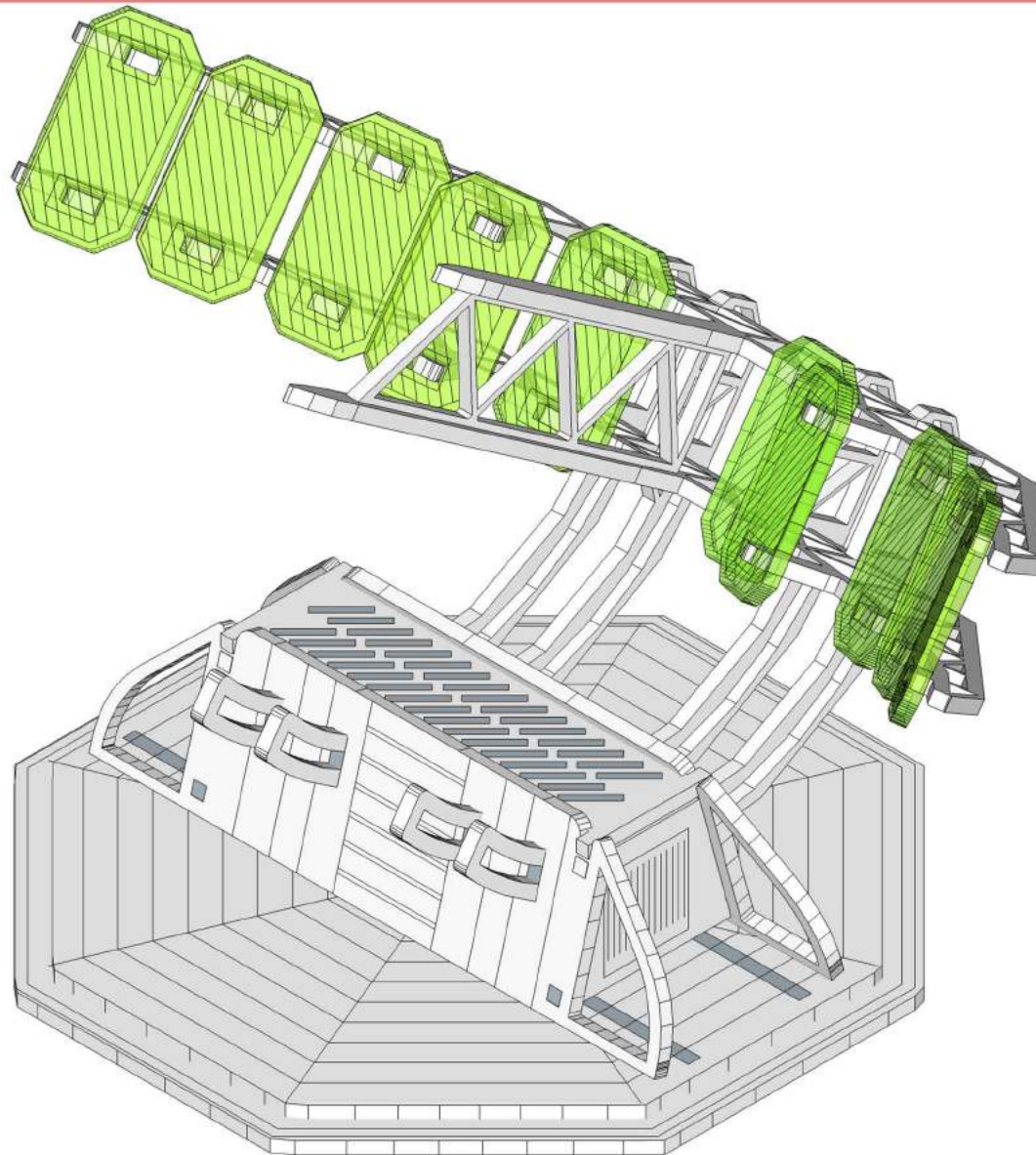

SLIDE THE CRADLE PARTS THROUGH THE HOLES SHOWN YOU WONT NEED TO GLUE THESE IN, THEYRE DESIGNED TO SLIDE FREELY.